

SPECIFICATION CONTROL DRAWING

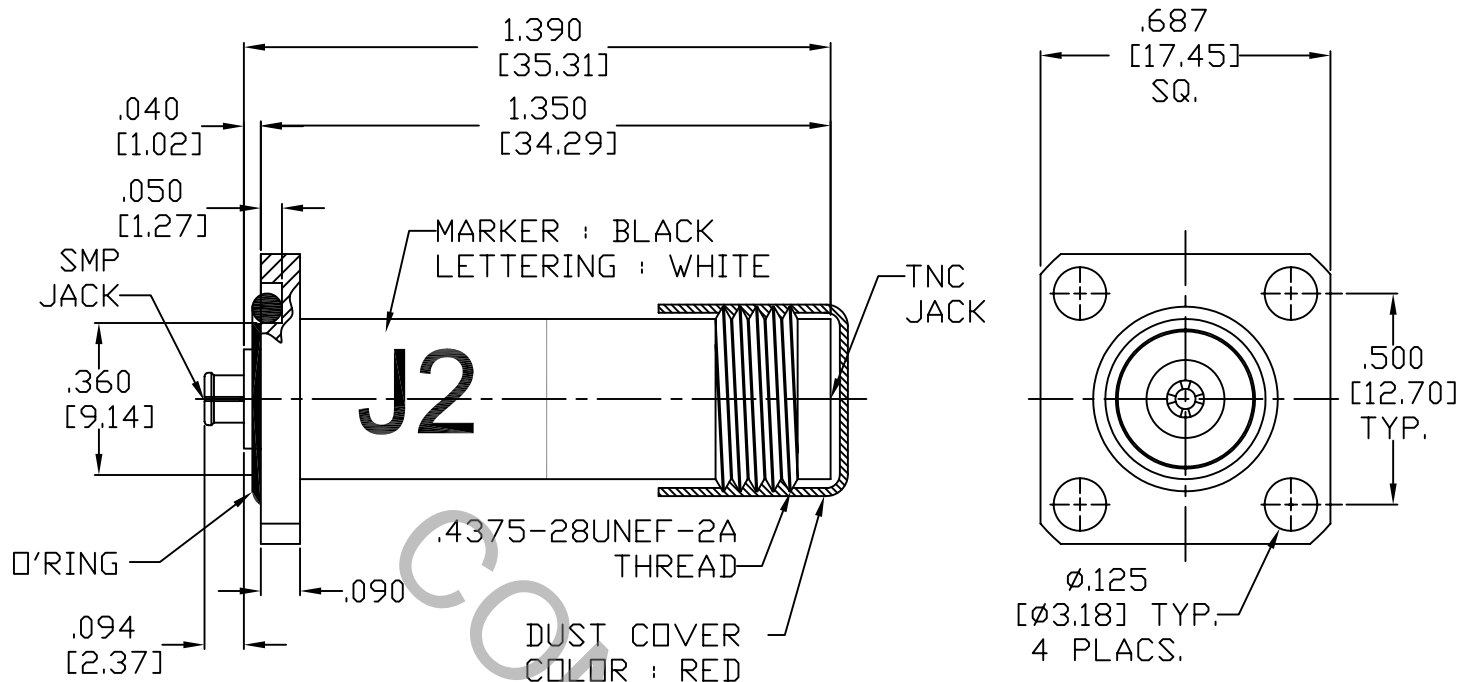

1. MATING INTERFACE DIMENSIONS Per MIL-STD-348 Fig. 326.1 (SMP, JACK). AND MIL-STD-348A, Fig. 313.2, (TNC, JACK)

2. ELECTRICAL

FREQUENCY RANGE GHz	_____	DC TO 1.1 GHz
VSWR (MAX) *	_____	1.08 + .015 x FGHz
INSERTION LOSS (dB MAX) *	_____	.10 dB x √FGHz
NOMINAL IMPEDANCE (OHMS)	_____	50
VOLTAGE RATING (MAX. VRMS)	_____	500
RF LEAKAGE (MIN. dB DOWN)	_____	-100 dB - FGHz
TEMPERATURE RATING (DEGREES CENTIGRADE)	_____	-65°C TO + 165°C
DIELECTRIC WITHSTANDING VOLTAGE (MAX. VRMS)	_____	500
INSULATION RESISTANCE (MIN. MEGOHMS)	_____	5,000
CONTACT RESISTANCE		
• CENTER CONTACT (MAX. MILLIOHMS)	_____	6.0
• OUTER CONTACT (MAX. MILLIOHMS)	_____	2.0

* TERMINATED IN A 50 OHM LOAD

RoHS
COMPLIANT

REV.	DCN NO.	DATE	APP.	DIMENSIONS ARE IN INCHES TOLERANCES			 HAVERHILL, MA 01835
AA	08-1954	11/5/08	TS	DECIMALS .X ± .030 .XX ± .010 .XXX ± .005	FRACTIONAL ± 1/64	ANGULAR X ° ± 1° 0' X ° X' ± 15'	
				DRAWN	TS	DATE	11/5/08
				APPROVED	DC	DATE	11/5/08
				CODE IDENT.	SHEET 1 OF 2		DWG. NO. 1154-2085-2710
				2J899			

TITLE
SMP, JACK TO
TNC, JACK, 4 HOLE FLANGE
MOUNT ADAPTER

SPECIFICATION CONTROL DRAWING

3. MECHANICAL

CAPTIVATION-CENTER CONTACT

MAX AXIAL FORCE _____ 6.0 LBS.

MAX RADIAL TORQUE _____ N/A

CENTER CONTACT AXIAL FORCES

● INSERTION (MAX. OUNCES) _____ INTERFACE 32.0

● WITHDRAWAL (MIN. OUNCES) _____ INTERFACE 2.0

CONNECTOR ENGAGEMENT/DISENGAGEMENT (MAX. LBS.) _____ 2.0

CONNECTOR DURABILITY (MIN. CYCLES) _____ 500

RECOMMENDED MATING TORQUE _____ 15 - 20 IN. LBS.

4. ENVIRONMENTAL

TEMPERATURE CYCLING _____ MIL-STD-202, METHOD 107, COND. C (-65° c TO + 165° c)

SHOCK _____ MIL-STD-202, METHOD 213, COND. I (100 G's)

VIBRATION _____ MIL-STD-202, METHOD 204, COND. D (20 G's)

MOISTURE RESISTANCE _____ MIL-STD-202, METHOD 106, LESS STEP 7b

CORROSION _____ MIL-STD-202, METHOD 101, COND. B (48 HOURS)

BAROMETRIC PRESSURE (ALTITUDE) _____ MIL-STD-202, METHOD 105, COND. C (70,000 FT.) (190 VRMS)

5. MATERIAL

TNC BODY _____ BRASS PER ASTM B 16, TEMPER H02, ALLOY C36000.

SMP BODY AND CONTACT _____ BERYLLIUM COPPER PER ASTM-B-196/B, 196M-03, COPPER ALLOY No. UNS-C17300, TEMPER TD04.

INSULATOR _____ TEFLON PER ASTM D-1710-02, TYPE 1, GRADE 1, CLASS B.

DUST COVER _____ VINYL (COLOR RED)

O'RING _____ SILICONE RUBBER PER ZZ-R-765E, CLASS 1.

6. FINISH

TNC BODY _____ NICKEL PER QQ-N-290, CLASS 1.

SMP BODY _____ GOLD PER ASTM-B-488, TYPE I, CODE C, CLASS 1.25
(.000050 MIN. THK.) OVER NICKEL per QQ-N-290
(.000150 MIN. THK.) OVER COPPER per MIL-C-14550
(.000010 MIN. THK.)

CONTACT _____ GOLD PER ASTM-B-488, TYPE I, CODE C, CLASS 2.5
(.000100 MIN. THK.) OVER NICKEL per QQ-N-290
(.000050 MIN. THK.) OVER COPPER per MIL-C-14550
(.000010 MIN. THK.)

INSULATOR, DUST COVER AND O'RING _____ N/A