

SPECIFICATION CONTROL DRAWING

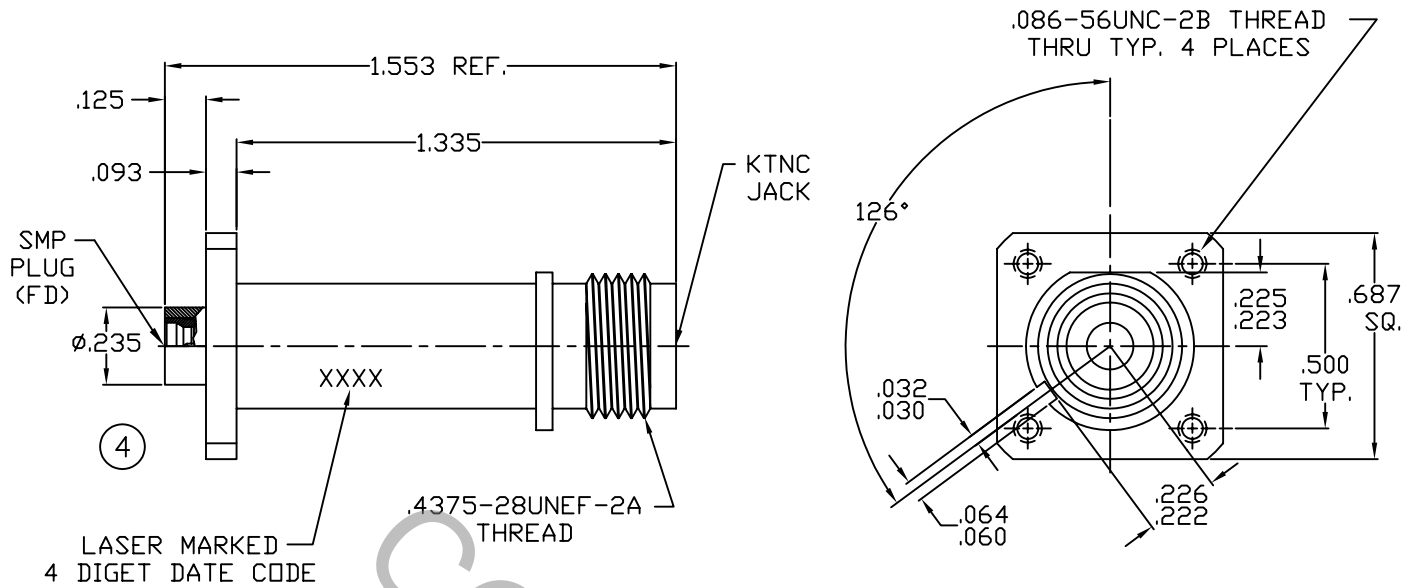

1. MATING INTERFACE DIMENSIONS MIL-STD-348 Fig. 313.2 (KTNC JACK).
AND MIL-STD-348 Fig. 326.2 (SMP, PLUG, FULL DETENT).

2. ELECTRICAL

FREQUENCY RANGE GHz	_____	DC TO 18.0 GHz
VSWR (MAX) *	_____	1.10 + .008 x FGHz
INSERTION LOSS (dB MAX) *	_____	.05 dB x $\sqrt{\text{FGHz}}$
NOMINAL IMPEDANCE (OHMS)	_____	50
VOLTAGE RATING (MAX. VRMS)	_____	170
RF LEAKAGE (MIN. dB DOWN)	_____	-100 dB - FGHz
TEMPERATURE RATING (DEGREES CENTIGRADE)	_____	-65°C TO + 165°C
DIELECTRIC WITHSTANDING VOLTAGE (MAX. VRMS)	_____	500
INSULATION RESISTANCE (MIN. MEGOHMS)	_____	5,000
CONTACT RESISTANCE		
• CENTER CONTACT (MAX. MILLIOHMS)	_____	3.0
• OUTER CONTACT (MAX. MILLIOHMS)	_____	2.0

* TERMINATED IN A 50 OHM LOAD

REV.	DCN NO.	DATE	APP.	DIMENSIONS ARE IN INCHES TOLERANCES			 HAVERHILL, MA 01835
				DECIMALS	FRACTIONAL	ANGULAR	
AA	98-0065	2/5/98	DGG	.X ± .030 .XX ± .010 .XXX ± .005	±/64	X ° ± 10' X ° X' ± 15'	TITLE KEYED (126°), KTNC JACK FLANGE MOUNT ADAPTER TO SMP, PLUG, FULL DETENT
AB	98-0470	6/1/98	DGG				
BA	06-2181			DRAWN	GL	DATE 2/2/98	
				APPROVED	DGG	DATE 2/5/98	
				CODE IDENT.	SHEET 1 OF 2		DWG. NO. 1154-2187-6208
				2J899			

SPECIFICATION CONTROL DRAWING

3. MECHANICAL

CAPTIVATION-CENTER CONTACT

MAX AXIAL FORCE _____ 6.0 LBS.

MAX RADIAL TORQUE _____ N/A

CENTER CONTACT AXIAL FORCES

● INSERTION (MAX. OUNCES) _____ KTNC INTERFACE 32.0

● WITHDRAWAL (MIN. OUNCES) _____ KTNC INTERFACE 2.0

CONNECTOR DURABILITY (MIN. CYCLES) KTNC AND SMP _____ 500

MATING REQUIREMENTS

ENGAGEMENT AXIAL FORCE (SMP) _____ 15.0 LBS. MAX.

DISENGAGEMENT AXIAL FORCE (SMP) _____ 5.0 LBS. MIN.

ENGAGEMENT TORQUE FORCE (KTNC) _____ 30.0 TO 35.0 IN./LBS.

4. ENVIRONMENTAL

TEMPERATURE CYCLING _____ MIL-STD-202, METHOD 102, COND. C (-65° c TO + 165° c)

SHOCK _____ MIL-STD-202, METHOD 213, COND. I (100 G's)

VIBRATION _____ MIL-STD-202, METHOD 204, COND. D (20 G's)

MOISTURE RESISTANCE _____ MIL-STD-202, METHOD 106, LESS STEP 7b

CORROSION _____ MIL-STD-202, METHOD 101, COND. B (48 HOURS)

BAROMETRIC PRESSURE (ALTITUDE) _____ MIL-STD-202, METHOD 105, COND. C (70,000 FT.) (125 VRMS)

5. MATERIAL

BODY _____ STAINLESS STEEL PER ASTM A581, TYPE 303, COND. A

CONTACT _____ BERYLLIUM COPPER PER ASTM B196-90, COPPER ALLOY
No. UNS-C17300, TEMPER TD04.

INSULATOR _____ TEFLON PER ASTM D 1710

6. FINISH

BODY _____ PASSIVATE PER AMS QQ-P-35, TYPE 2.

CONTACT _____ GOLD PER ASTM B 488, TYPE II, CODE C, CLASS 2.5
(.000100 MIN. THK.) OVER NICKEL per QQ-N-290
(.000050 MIN. THK.) OVER COPPER per MIL-C-14550
(.000010 MIN. THK.)

INSULATOR _____ N/A