

SPECIFICATION CONTROL DRAWING

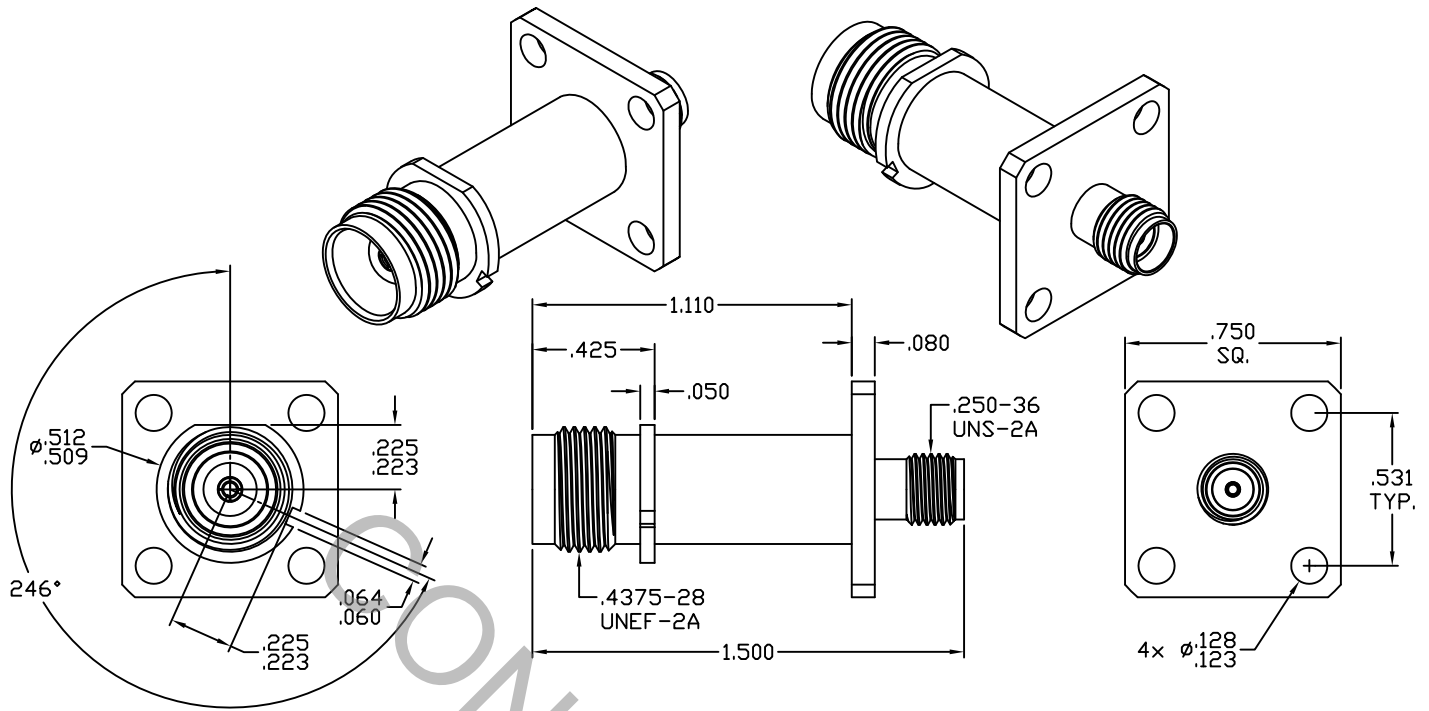

1. MATING INTERFACE DIMENSIONS Per MIL-STD-348
Fig. 313.2 (TNC JACK) AND 310.2 (SMA JACK).

2. ELECTRICAL

FREQUENCY RANGE GHz	_____	DC TO 18.0 GHz
VSWR (MAX.) *	_____	1.07 + .008 x FGHz
INSERTION LOSS (dB MAX.) *	_____	.085 dB x $\sqrt{\text{FGHz}}$
NOMINAL IMPEDANCE (OHMS)	_____	50
VOLTAGE RATING (MAX. VRMS)	_____	500
RF LEAKAGE (MIN. dB DOWN)	_____	-100 dB - FGHz
TEMPERATURE RATING (DEGREES CENTIGRADE)	_____	-65°C TO + 165°C
DIELECTRIC WITHSTANDING VOLTAGE (MAX. VRMS)	_____	1,500
INSULATION RESISTANCE (MIN. MEGOHMS)	_____	5,000
CONTACT RESISTANCE		
• CENTER CONTACT (MAX. MILLIOHMS)	_____	3.0
• OUTER CONTACT (MAX. MILLIOHMS)	_____	2.0

* TERMINATED IN A 50 OHM LOAD

RoHS
COMPLIANT

REV.	DCN NO.	DATE	APP.	DIMENSIONS ARE IN INCHES TOLERANCES			 HAVERHILL, MA 01835
AA	11-1375	4/28/11	DC	DECIMALS .X ± .030 .XX ± .010 .XXX ± .005	FRACTIONAL ± 1/64	ANGULAR X ° ± 1° 0' X ° X' ± 15'	
				DRAWN	DC	DATE 4/28/11	TITLE KTNC JACK (KEYED 246°) 4 HOLE FLANGE MOUNT TO SMA JACK ADAPTER
				APPROVED	DC	DATE 4/28/11	
				CODE IDENT.	SHEET 1 OF 2		DWG. NO. 1154-8799-6228
				2J899			

SPECIFICATION CONTROL DRAWING

3. MECHANICAL

CAPTIVATION-CENTER CONTACT

MAX AXIAL FORCE _____ 6.0 LBS.

MAX RADIAL TORQUE _____ N/A

CENTER CONTACT AXIAL FORCES

● INSERTION (MAX OUNCES) _____ INTERFACE 32.0

● WITHDRAWAL (MIN. OUNCES) _____ INTERFACE 2.0

CONNECTOR ENGAGEMENT/DISENGAGEMENT (MAX LBS.) _____ 2.0

CONNECTOR DURABILITY (MIN. CYCLES) _____ 500

RECOMMENDED MATING TORQUE _____ SMA 7 - 10 IN. LBS.
TNC 30 - 35 IN. LBS.

4. ENVIRONMENTAL

TEMPERATURE CYCLING _____ MIL-STD-202, METHOD 102, COND. C (-65° c TO +165° c)

SHOCK _____ MIL-STD-202, METHOD 213, COND. I (100 G's)

VIBRATION _____ MIL-STD-202, METHOD 204, COND. D (20 G's)

MOISTURE RESISTANCE _____ MIL-STD-202, METHOD 106, LESS STEP 7b

CORROSION _____ MIL-STD-202, METHOD 101, COND. B (48 HOURS)

BAROMETRIC PRESSURE (ALTITUDE) _____ MIL-STD-202, METHOD 105, COND. C (70,000 FT.) (375 VRMS)

5. MATERIAL

BODY, HEX NUT & LOCKWASHER _____ STAINLESS STEEL PER ASTM-A-582, TYPE 303, COND. A

CONTACT _____ BERYLLIUM COPPER PER ASTM-B-196/B, 196M-03, COPPER ALLOY No. UNS-C17300, TEMPER TD04.

INSULATOR _____ TEFLON PER ASTM D 1710-02, TYPE 1, GRADE 1, CLASS B.

6. FINISH

BODY _____ PASSIVATE PER AMS-2700, TYPE 2, CLASS 4.

CONTACT _____ GOLD PER ASTM-B-488, TYPE I, CODE C, CLASS 1.27
(.000050 MIN. THK.) OVER NICKEL per SAE-AMS-QQ-N-290,
CLASS 1 (.000050 MIN. THK.) OVER COPPER per AMS-2418
(.000010 MIN. THK.)

INSULATOR _____ N/A