

SPECIFICATION CONTROL DRAWING

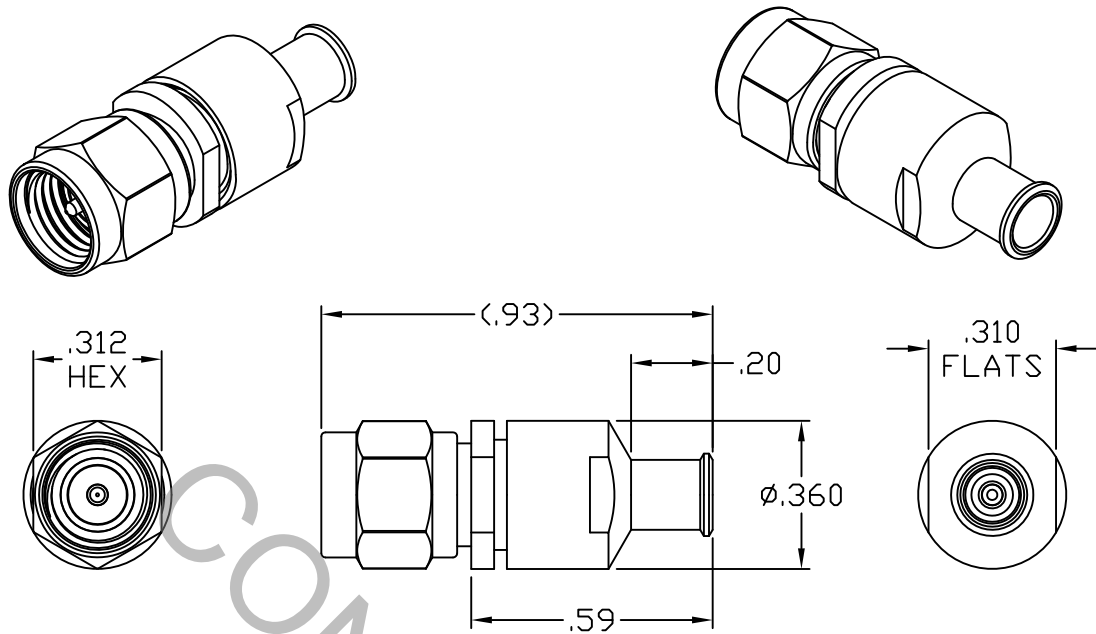

1. MATING INTERFACE DIMENSIONS Per MIL-STD-348 Fig. 310.1 (SMA PLUG).

2. ELECTRICAL

FREQUENCY RANGE GHz	_____	DC TO 26.5 GHz
VSWR (MAX.) *	_____	1.05 + .005 x FGHz
INSERTION LOSS (dB MAX.) *	_____	.04 dB x $\sqrt{\text{FGHz}}$
NOMINAL IMPEDANCE (OHMS)	_____	50
VOLTAGE RATING (MAX. VRMS)	_____	333
RF LEAKAGE (MIN. dB DOWN)	_____	-100 dB - FGHz
TEMPERATURE RATING (DEGREES CENTIGRADE)	_____	-65° TO + 165°c
DIELECTRIC WITHSTANDING VOLTAGE (MAX. VRMS)	_____	1,000
INSULATION RESISTANCE (MIN. MEGOHMS)	_____	5,000
CONTACT RESISTANCE		
• CENTER CONTACT (MAX. MILLIOHMS)	_____	6.0
• OUTER CONTACT (MAX. MILLIOHMS)	_____	2.0

* TERMINATED IN A 50 OHM LOAD

RoHS
COMPLIANT

REV.	DCN NO.	DATE	APP.	DIMENSIONS ARE IN INCHES TOLERANCES			 HAVERHILL, MA 01835	
AA	10-1795	8/31/10	DC	DECIMALS .X ± .030 .XX ± .010 .XXX ± .005	FRACTIONAL ± 1/64	ANGULAR X ° ± 1° 0' X ° X' ± 15'		
				DRAWN	DC	DATE	8/30/10	TITLE SMA PLUG SOLDER CLAMP DF465 LOW LOSS
				APPROVED	DC	DATE	8/30/10	
				CODE IDENT.	SHEET 1 OF 2		DWG. NO.	9800-465H-6200
				2J899				

SPECIFICATION CONTROL DRAWING

3. MECHANICAL

CAPTIVATION-CENTER CONTACT

MAX AXIAL FORCE _____ 6.0 LBS.

MAX RADIAL TORQUE _____ N/A

CENTER CONTACT AXIAL FORCES

● INSERTION (MAX OUNCES) _____ N/A

● WITHDRAWAL (MIN. OUNCES) _____ N/A

CONNECTOR ENGAGEMENT/DISENGAGEMENT (MAX LBS.) _____ 2.0

CONNECTOR DURABILITY (MIN. CYCLES) _____ 500

RECOMMENDED MATING TORQUE _____ 7 - 10 IN. LBS.

4. ENVIRONMENTAL

TEMPERATURE CYCLING _____ MIL-STD-202, METHOD 107, COND. C (-65° c TO + 165° c)

SHOCK _____ MIL-STD-202, METHOD 213, COND. I (100 G's)

VIBRATION _____ MIL-STD-202, METHOD 204, COND. D (20 G's)

MOISTURE RESISTANCE _____ MIL-STD-202, METHOD 106, LESS STEP 7b

CORROSION _____ MIL-STD-202, METHOD 101, COND. B (48 HOURS)

BAROMETRIC PRESSURE (ALTITUDE) _____ MIL-STD-202, METHOD 105, COND. C (70,000 FT.) (250 VRMS)

5. MATERIAL

BODY, COUPLING NUT, CLAMP NUT & BUSHING _____ STAINLESS STEEL PER ASTM-A-582, TYPE 303, COND. A

CONTACT & RETAINING RING _____ BERYLLIUM COPPER PER ASTM-B-196/B, 196M-03, COPPER ALLOY No. UNS-C17300, TEMPER TD04.

INSULATORS _____ TEFLON PER ASTM-D-1710-02, TYPE 1, GRADE 1, CLASS B.

GASKET _____ SILICONE RUBBER PER ZZ-R-765.

SOLDER SLEEVE _____ BRASS PER ASTM-B-16, TEMPER H02, ALLOY C36000.

6. FINISH

BODY, COUPLING NUT, CLAMP NUT & BUSHING _____ PASSIVATE PER AMS-2700, TYPE 2, CLASS 4.

SOLDER SLEEVE _____ GOLD PER ASTM-B-488, TYPE I, CODE C, CLASS 1.25
(.000050 MIN. THK.) OVER NICKEL per SAE AMS-QQ-N-290
(.000150 MIN. THK.) OVER NICKEL (WOODS OR WATTS)
(.000010 MIN. THK.)

CONTACT _____ GOLD PER ASTM-B-488, TYPE I, CODE C, CLASS 2.5
(.000100 MIN. THK.) OVER NICKEL per SAE AMS-QQ-N-290
(.000050 MIN. THK.) OVER COPPER per AMS-2418
(.000010 MIN. THK.)

INSULATORS, RETAINING RING & GASKET _____ N/A