

SPECIFICATION CONTROL DRAWING

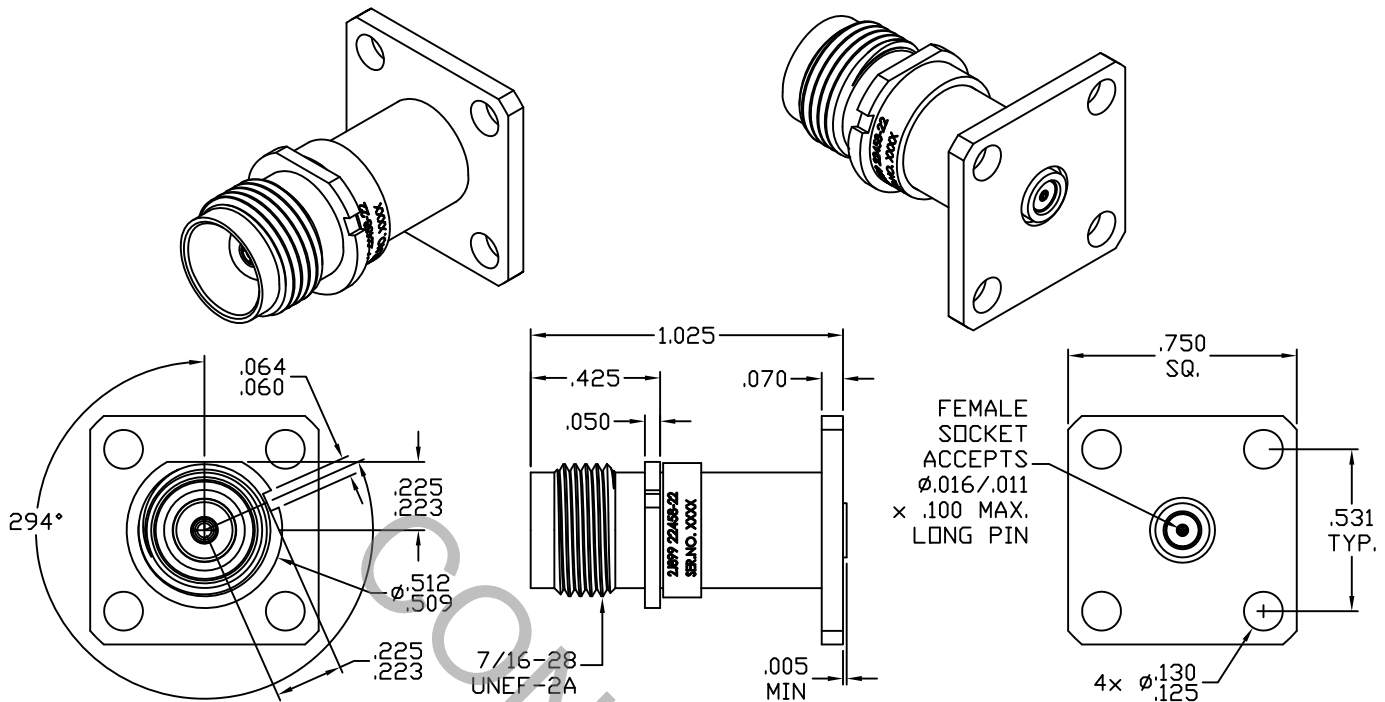

1. MATING INTERFACE DIMENSIONS Per MIL-STD-348 Fig. 313.2 (TNC JACK).

2. ELECTRICAL

FREQUENCY RANGE GHz	_____	DC TO 18.0 GHz
VSWR (MAX.) *	_____	1.13 + .012 x FGHz
INSERTION LOSS (dB MAX.) *	_____	.05 dB x $\sqrt{\text{FGHz}}$
NOMINAL IMPEDANCE (OHMS)	_____	50
VOLTAGE RATING (MAX. VRMS)	_____	250
RF LEAKAGE (MIN. dB DOWN)	_____	-100 dB - FGHz
TEMPERATURE RATING (DEGREES CENTIGRADE)	_____	-65°C TO + 165°C
DIELECTRIC WITHSTANDING VOLTAGE (MAX. VRMS)	_____	750
INSULATION RESISTANCE (MIN. MEGOHMS)	_____	5,000
CONTACT RESISTANCE		
• CENTER CONTACT (MAX. MILLIOHMS)	_____	6.0
• OUTER CONTACT (MAX. MILLIOHMS)	_____	2.0

* TERMINATED IN A 50 OHM LOAD

RoHS
COMPLIANT

REV.	DCN NO.	DATE	APP.	DIMENSIONS ARE IN INCHES TOLERANCES			 HAVERHILL, MA 01835	
AA	11-1297	3/28/11	DC	DECIMALS .X ± .030 .XX ± .010 .XXX ± .005	FRACTIONAL ± 1/64	ANGULAR X ° ± 1° 0' X ° X' ± 15'		
				DRAWN	DC	DATE	3/28/11	TITLE TNC JACK, 4 HOLE FLANGE, KEYED FLANGE, EMI, ACCEPTS 0.016/.011 PIN
				APPROVED	DC	DATE	3/28/11	
				CODE IDENT.		SHEET	1 OF 2	DWG. NO. 8754-0722-6215
				2J899				

SPECIFICATION CONTROL DRAWING

3. MECHANICAL

CAPTIVATION-CENTER CONTACT

MAX AXIAL FORCE _____ 4.5 LBS.

MAX RADIAL TORQUE _____ N/A

CENTER CONTACT AXIAL FORCES

● INSERTION (MAX OUNCES) _____ INTERFACE 32.0, REAR * 32.0 *

● WITHDRAWAL (MIN. OUNCES) _____ INTERFACE 2.0, REAR * 1.0 *

CONNECTOR ENGAGEMENT/DISENGAGEMENT (MAX LBS.) _____ 2.0

CONNECTOR DURABILITY (MIN. CYCLES) _____ 500

RECOMMENDED MATING TORQUE _____ 7 - 10 IN. LBS.

* WHEN TESTED TO .012 ±.001 OR .015 ±.001 FEED THRU SIZE *

4. ENVIRONMENTAL

TEMPERATURE CYCLING _____ MIL-STD-202, METHOD 107, COND. C (-65° c TO +165° c)

SHOCK _____ MIL-STD-202, METHOD 213, COND. I (100 G's)

VIBRATION _____ MIL-STD-202, METHOD 204, COND. D (20 G's)

MOISTURE RESISTANCE _____ MIL-STD-202, METHOD 106, LESS STEP 7b

CORROSION _____ MIL-STD-202, METHOD 101, COND. B (48 HOURS)

BAROMETRIC PRESSURE (ALTITUDE) _____ MIL-STD-202, METHOD 105, COND. C (70,000 FT.) (190 VRMS)

5. MATERIAL

BODY _____ STAINLESS STEEL PER ASTM-A-582, TYPE 303, COND. A

CONTACT _____ BERYLLIUM COPPER PER ASTM-B-196/B, 196M-03, COPPER ALLOY No. UNS-C17300, TEMPER TD04.

INSULATOR _____ TEFLON PER ASTM-D-1710-02, TYPE 1, GRADE 1, CLASS B.

EMI GASKET _____ SILVER PLATED ALUMINUM IN SILICONE PER MIL-G-83528, TYPE B.

MARKER _____ MIL-DTL-23053/5, WHITE

6. FINISH

BODY _____ PASSIVATE PER AMS-2700, TYPE 2, CLASS 4.

CONTACT _____ GOLD PER ASTM-B-488, TYPE I, CODE C, CLASS 1.27 (.000050 MIN. THK.) OVER NICKEL PER SAE-AMS-QQ-N-290 CLASS 1 (.000050 MIN. THK.) OVER COPPER PER AMS-2418 (.000010 MIN. THK.)

INSULATOR & MARKER _____ N/A